



### Main

Range of product	Altivar 212
Product or component type	Variable speed drive
Device short name	ATV212
Product destination	Asynchronous motors
Product specific application	Pumps and fans in HVAC
Assembly style	With heat sink
Network number of phases	3 phases
Motor power kW	4 kW
Motor power hp	5 hp
[Us] rated supply voltage	380...480 V - 15...10 %
Supply voltage limits	323...528 V
Supply frequency	50...60 Hz - 5...5 %
EMC filter	Class C2 EMC filter integrated
Line current	6.4 A at 480 V 8.1 A at 380 V

### Complementary

Apparent power	6.9 kVA at 380 V
Prospective line I <sub>sc</sub>	5 kA
Continuous output current	9.1 A at 380 V 9.1 A at 460 V
Maximum transient current	10 A for 60 s
Speed drive output frequency	0.5...200 Hz
Nominal switching frequency	12 kHz
Switching frequency	6...16 kHz adjustable 12...16 kHz with derating factor
Speed range	1...10

Speed accuracy	+/- 10 % of nominal slip 0.2 Tn to Tn
Torque accuracy	+/- 15 %
Transient overtorque	120 % of nominal motor torque +/- 10 % for 60 s
Asynchronous motor control profile	Flux vector control without sensor, standard Voltage/frequency ratio, automatic IR compensation (U/f + automatic U <sub>0</sub> ) Voltage/frequency ratio, 5 points Voltage/frequency ratio, 2 points Voltage/frequency ratio - Energy Saving, quadratic U/f
Regulation loop	Adjustable PI regulator
Motor slip compensation	Not available in voltage/frequency ratio motor control Adjustable Automatic whatever the load
Local signalling	1 LED (red) for DC bus energized
Output voltage	<= power supply voltage
Isolation	Electrical between power and control
Type of cable	Without mounting kit: 1 wire(s)IEC cable at 45 °C, copper 90 °C / XLPE/EPR Without mounting kit: 1 wire(s)IEC cable at 45 °C, copper 70 °C / PVC With UL Type 1 kit: 3 wire(s)UL 508 cable at 40 °C, copper 75 °C / PVC
Electrical connection	VIA, VIB, FM, FLA, FLB, FLC, RY, RC, F, R, RES: terminal 2.5 mm <sup>2</sup> / AWG 14 L1/R, L2/S, L3/T: terminal 6 mm <sup>2</sup> / AWG 10
Tightening torque	1.3 N.m, 11.5 lb.in (L1/R, L2/S, L3/T) 0.6 N.m (VIA, VIB, FM, FLA, FLB, FLC, RY, RC, F, R, RES)
Supply	Internal supply for reference potentiometer (1 to 10 kOhm): 10.5 V DC +/- 5 %, <10 A, protection type: overload and short-circuit protection Internal supply: 24 V DC (21...27 V), <200 A, protection type: overload and short-circuit protection
Analogue input number	2
Analogue input type	VIA switch-configurable voltage: 0...10 V DC 24 V max, impedance: 30000 Ohm, resolution 10 bits VIB configurable voltage: 0...10 V DC 24 V max, impedance: 30000 Ohm, resolution 10 bits VIB configurable PTC probe: 0...6 probes, impedance: 1500 Ohm VIA switch-configurable current: 0...20 mA, impedance: 250 Ohm, resolution 10 bits
Sampling duration	2 ms +/- 0.5 ms F discrete 2 ms +/- 0.5 ms R discrete 2 ms +/- 0.5 ms RES discrete 3.5 ms +/- 0.5 ms VIA analog 22 ms +/- 0.5 ms VIB analog
Response time	FM 2 ms, tolerance +/- 0.5 ms for analog output(s) FLA, FLC 7 ms, tolerance +/- 0.5 ms for discrete output(s) FLB, FLC 7 ms, tolerance +/- 0.5 ms for discrete output(s) RY, RC 7 ms, tolerance +/- 0.5 ms for discrete output(s)
Accuracy	+/- 0.6 % (VIA) for a temperature variation 60 °C +/- 0.6 % (VIB) for a temperature variation 60 °C +/- 1 % (FM) for a temperature variation 60 °C
Linearity error	VIA: +/- 0.15 % of maximum value for input VIB: +/- 0.15 % of maximum value for input FM: +/- 0.2 % for output
Analogue output number	1
Analogue output type	FM switch-configurable voltage 0...10 V DC, impedance: 7620 Ohm, resolution 10 bits FM switch-configurable current 0...20 mA, impedance: 970 Ohm, resolution 10 bits
Discrete output number	2
Discrete output type	Configurable relay logic: (FLA, FLC) NO - 100000 cycles Configurable relay logic: (FLB, FLC) NC - 100000 cycles Configurable relay logic: (RY, RC) NO - 100000 cycles
Minimum switching current	3 mA at 24 V DC for configurable relay logic
Maximum switching current	5 A at 250 V AC on resistive load - cos phi = 1 - L/R = 0 ms (FL, R) 5 A at 30 V DC on resistive load - cos phi = 1 - L/R = 0 ms (FL, R) 2 A at 250 V AC on inductive load - cos phi = 0.4 - L/R = 7 ms (FL, R) 2 A at 30 V DC on inductive load - cos phi = 0.4 - L/R = 7 ms (FL, R)
Discrete input type	F programmable 24 V DC, with level 1 PLC, impedance: 4700 Ohm R programmable 24 V DC, with level 1 PLC, impedance: 4700 Ohm RES programmable 24 V DC, with level 1 PLC, impedance: 4700 Ohm
Discrete input logic	Positive logic (source) (F, R, RES), <= 5 V (state 0), >= 11 V (state 1) Negative logic (sink) (F, R, RES), >= 16 V (state 0), <= 10 V (state 1)
Acceleration and deceleration ramps	Automatic based on the load Linear adjustable separately from 0.01 to 3200 s

Braking to standstill	By DC injection
Protection type	Overheating protection: drive Thermal power stage: drive Short-circuit between motor phases: drive Input phase breaks: drive Overcurrent between output phases and earth: drive Overvoltages on the DC bus: drive Break on the control circuit: drive Against exceeding limit speed: drive Line supply overvoltage and undervoltage: drive Line supply undervoltage: drive Against input phase loss: drive Thermal protection: motor Motor phase break: motor With PTC probes: motor
Dielectric strength	3535 V DC between earth and power terminals 5092 V DC between control and power terminals
Insulation resistance	>= 1 mOhm 500 V DC for 1 minute
Frequency resolution	Display unit: 0.1 Hz Analog input: 0.024/50 Hz
Communication port protocol	Modbus APOGEE FLN METASYS N2 BACnet LonWorks
Connector type	1 RJ45 1 open style
Physical interface	2-wire RS 485
Transmission frame	RTU
Transmission rate	9600 bps or 19200 bps
Data format	8 bits, 1 stop, odd even or no configurable parity
Type of polarization	No impedance
Number of addresses	1...247
Communication service	Monitoring inhibitable Read holding registers (03) 2 words maximum Time out setting from 0.1 to 100 s Read device identification (43) Write multiple registers (16) 2 words maximum Write single register (06)
Option card	Communication card for LonWorks
Operating position	Vertical +/- 10 degree
Width	230 mm
Height	340 mm
Depth	208 mm
Net weight	9.65 kg
Functionality	Mid
Specific application	HVAC
IP degree of protection	IP55

## Environment

Electromagnetic compatibility	Electrostatic discharge immunity test level 3 conforming to IEC 61000-4-2 Radiated radio-frequency electromagnetic field immunity test level 3 conforming to IEC 61000-4-3 Electrical fast transient/burst immunity test level 4 conforming to IEC 61000-4-4 1.2/50 $\mu$ s - 8/20 $\mu$ s surge immunity test level 3 conforming to IEC 61000-4-5 Conducted radio-frequency immunity test level 3 conforming to IEC 61000-4-6 Voltage dips and interruptions immunity test conforming to IEC 61000-4-11
Pollution degree	3 conforming to IEC 61800-5-1
IP degree of protection	IP55 conforming to EN/IEC 61800-5-1 IP55 conforming to EN/IEC 60529
Vibration resistance	1.5 mm (f= 3...13 Hz) conforming to EN/IEC 60068-2-6 1 gn (f= 13...200 Hz) conforming to EN/IEC 60068-2-8
Shock resistance	15 gn for 11 ms conforming to IEC 60068-2-27

Environmental characteristic	Classes 3C1 conforming to IEC 60721-3-3 Classes 3S2 conforming to IEC 60721-3-3
Noise level	55 dB conforming to 86/188/EEC
Operating altitude	1000...3000 m limited to 2000 m for the Corner Grounded distribution network with current derating 1 % per 100 m <= 1000 m without derating
Relative humidity	5...95 % without condensation conforming to IEC 60068-2-3 5...95 % without dripping water conforming to IEC 60068-2-3
Ambient air temperature for operation	-10...40 °C (without derating) 40...50 °C (with derating factor)
Ambient air temperature for storage	-25...70 °C
Standards	EN 61800-3 environments 2 category C2 EN 61800-3 EN 61800-3 environments 2 category C1 EN 61800-3 category C2 IEC 61800-3 environments 2 category C3 IEC 61800-3 environments 1 category C3 EN 61800-3 category C3 IEC 61800-3 category C3 IEC 61800-3 environments 2 category C2 IEC 61800-3 environments 2 category C1 EN 61800-5-1 IEC 61800-5-1 IEC 61800-3 category C2 EN 55011 class A group 1 EN 61800-3 environments 1 category C2 IEC 61800-3 EN 61800-3 environments 1 category C3 IEC 61800-3 environments 1 category C2 EN 61800-3 environments 2 category C3 IEC 61800-3 environments 1 category C1 EN 61800-3 environments 1 category C1
Product certifications	NOM 117 UL C-Tick CSA
Marking	CE

## Packing Units

Unit Type of Package 1	PCE
Number of Units in Package 1	1
Package 1 Weight	9.036 kg
Package 1 Height	31 cm
Package 1 width	41 cm
Package 1 Length	32 cm
Unit Type of Package 2	P06
Number of Units in Package 2	4
Package 2 Weight	49.14 kg
Package 2 Height	80 cm
Package 2 width	80 cm
Package 2 Length	60 cm

## Offer Sustainability

Sustainable offer status	Green Premium product
REACH Regulation	<a href="#">REACH Declaration</a>
EU RoHS Directive	Pro-active compliance (Product out of EU RoHS legal scope) <a href="#">EU RoHS Declaration</a>
Mercury free	Yes
RoHS exemption information	<a href="#">Yes</a>
China RoHS Regulation	<a href="#">China RoHS declaration</a>
Environmental Disclosure	<a href="#">Product Environmental Profile</a>

---

Circularity Profile	<a href="#">End of Life Information</a>
WEEE	The product must be disposed on European Union markets following specific waste collection and never end up in rubbish bins

---

### Contractual warranty

---

Warranty	18 months
----------	-----------

---

Dimensions

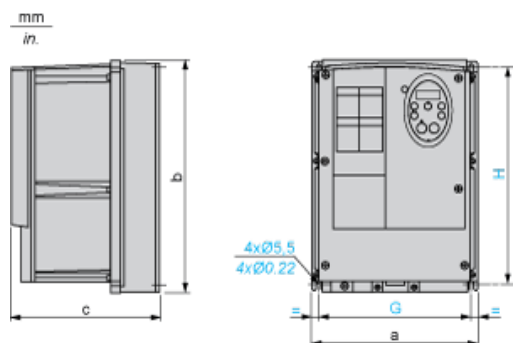

Dimensions in mm

ATV212W	a	b	c	G	H
075N4...U22N4 075N4C...U22N4C	215	297	192	197	277
U30N4...U75N4 U30N4C...U75N4C	230	340	208	212	318

Dimensions in in.

ATV212W	a	b	c	G	H
075N4...U22N4 075N4C...U22N4C	8.46	11.69	7.56	7.76	10.91
U30N4...U75N4 U30N4C...U75N4C	9.06	13.39	8.19	8.35	12.52

---

## Mounting Recommendations

---

### Clearance

Depending on the conditions in which the drive is to be used, its installation will require certain precautions and the use of appropriate accessories.

Install the unit vertically:

- Do not place it close to heating elements.
- Leave sufficient free space to ensure that the air required for cooling purposes can circulate from bottom to the top of the unit.

### Type A Mounting

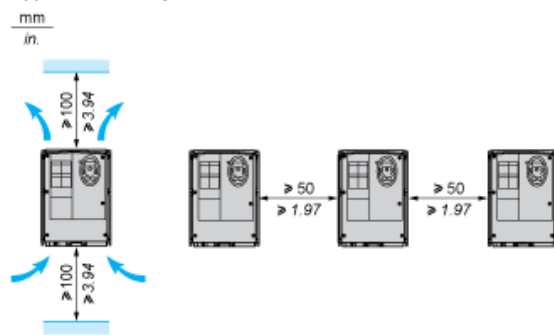

Recommended Wiring Diagram

3-Phase Power Supply

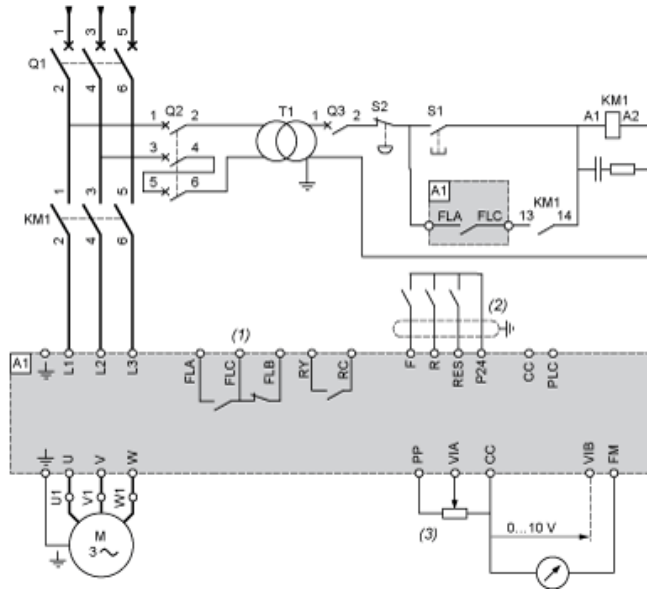

- A1: ATV 212 drive
- KM1: Contactor
- Q1: Circuit breaker
- Q2: GV2 L rated at twice the nominal primary current of T1
- Q3: GB2CB05
- S1, S2: XB4 B or XB5 A pushbuttons
- T1: 100 VA transformer 220 V secondary
- (1) Fault relay contacts for remote signalling of the drive status
- (2) Connection of the common for the logic inputs depends on the positioning of the switch (Source, PLC, Sink)
- (3) Reference potentiometer SZ1RV1202

NOTE: All terminals are located at the bottom of the drive. Install interference suppressors on all inductive circuits near the drive or connected on the same circuit, such as relays, contactors, solenoid valves, fluorescent lighting, etc.

Switches (Factory Settings)

Voltage/current selection for analog I/O (VIA and VIB)



Voltage/current selection for analog I/O (FM)



Selection of logic type

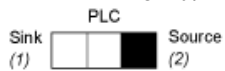

- (1) negative logic
- (2) positive logic



Other Possible Wiring Diagrams

Logic Inputs According to the Position of the Logic Type Switch

“Source” position



“Sink” position

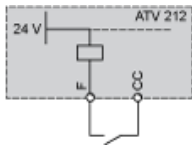

“PLC” position with PLC transistor outputs

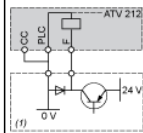

(1) PLC

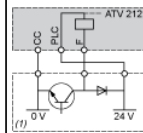

(1) PLC

2-wire control

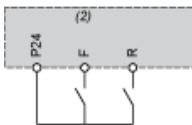

- F: Forward
- R: Preset speed
- (2) ATV 212 control terminals

3-wire control

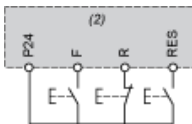

- F: Forward
- R: Stop
- RES: Reverse
- (2) ATV 212 control terminals

PTC probe

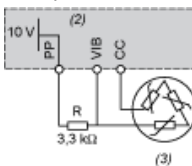

- (2) ATV 212 control terminals
- (3) Motor

Analogue Inputs

Voltage analog inputs

External +10 V

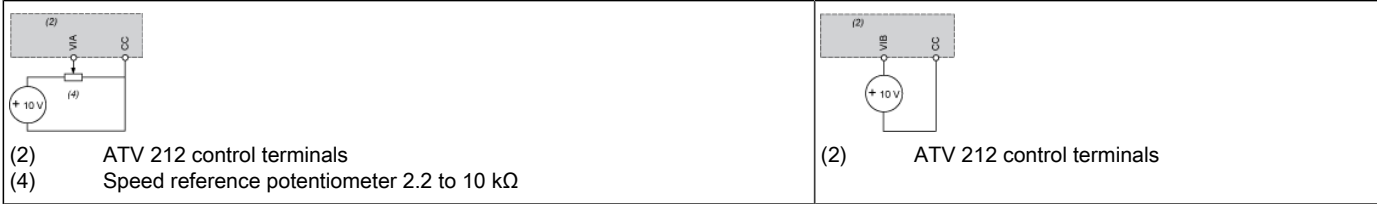

Analog input configured for current: 0-20 mA, 4-20 mA, X-Y mA

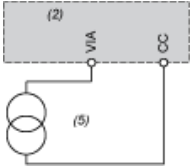

- (2) ATV 212 control terminals
- (5) Source 0-20 mA, 4-20 mA, X-Y mA

Analog input VIA configured as positive logic input ("Source" position)



- (2) ATV 212 control terminals

Analog input VIA configured as negative logic input ("Sink" position)

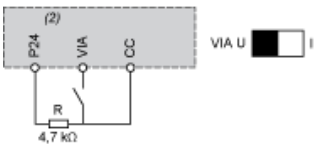

- (2) ATV 212 control terminals

---

### Derating Curves

---

The derating curves for the drive nominal current ( $I_n$ ) depend on the temperature and the switching frequency.  
For intermediate temperatures (45°C for example), interpolate between 2 curves.

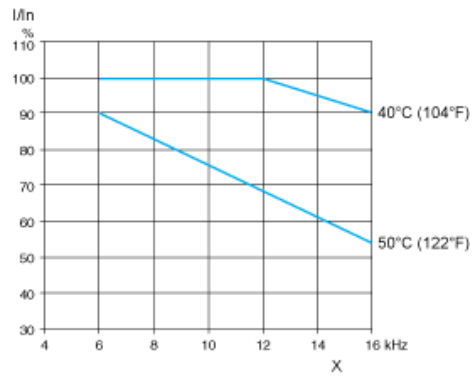

X Switching frequency